

# Site Analysis for Wind Generators

## Part 1: Average Wind Speed

Mick Sagrillo

©1994 Mick Sagrillo

**Y**ou've decided that it's time to consider a wind electric system. It sure seems windy in your area, at least part of the time anyway. And you could really use the power!

But how can you tell if a wind generator will really do well at your site? How do you know if you have enough wind, and where the wind is? And if it turns out that you do have a good resource, where's the best place to put the tower?

### Tools

The common response to the above questions is that you must monitor the wind speed at your site for a year or two to find out if a wind generator will work for you. For a residential-sized system, this is nonsense! PV installers don't record available sunlight forever, so why do it for wind? Actually, PV installers have a couple of tools at hand to help them site PV arrays. We can do the same for wind generators.

In order to correctly site and size a wind electric system, it is helpful to have the following information about your location:

- average annual wind speed
- prevailing wind directions
- vegetation and buildings at the site
- surface roughness
- the type of energy storage

What we need to do is quantify your resource in general terms first. Once that is done, we can fine tune your resource for your specific site. So, let's analyze each of these tools and see how to use them.

### Options

Because it is so easy to address, let's consider the type of energy storage first. If utility electricity is available to you, by all means, consider a utility tie-in system. By using the grid, you eliminate the need for a very expensive and time consuming component: the

batteries. In a grid intertie system, the utility stores your electricity in the form of a credit whenever the wind is blowing. When the wind is still, you reclaim that credited power. In this case, your primary concern is producing enough electricity over extended periods of time to offset your consumption of utility-generated power. Daily or weekly production is irrelevant.

If yours is a remote system utilizing batteries rather than the utility grid, then you can actually do with less wind than the minimum cost-effective grid intertie system. Any renewable source of energy is more cost effective than running, maintaining, and fueling a gas or diesel generator for several decades.

In the case of a utility intertie system, a ten mph average annual wind speed is usually considered the cut-off. Below ten mph, the wind generator cannot be justified on a purely economic basis compared to purchased utility power. With a stand-alone system, wind generators are certainly cost effective in the nine mph and even the eight mph average wind speed ranges. These numbers refer to wind speeds at the height of the blades, referred to as hub height. The big question is, how do you get these numbers for your site?

### You What???

Determining your exact average annual wind speed is difficult, expensive, and time-consuming. But, Mick, you say, you just told us that monitoring the wind for a year or so was nonsense. What gives?

While it is necessary to have an idea of your average annual wind speed, you do not need an exact measurement. We're not prospecting for a wind farm here. Therefore, monitoring wind speed at hub height for several years is unnecessary.

So how do we get this elusive number called average wind speed. We guess. Don't laugh! It's done all of the time, and fairly accurately, I might add. What we need to do is get a ballpark idea of the average annual wind speed for your area. I'll explain how it was done at my site, and we can work backwards from there.

### Conventional Wisdom

When we moved to our homestead in Wisconsin, we investigated the use of a wind generator because it always "seemed" so windy. Conventional wisdom said to check the airport and weather bureau data for our area. We found that the average annual wind speed at the Green Bay airport, 35 miles away, was barely nine mph, hardly worth considering due to the cost of electricity we were buying from the utility.

After replanting the same peas in our first garden four times (they kept blowing out of the ground), we asked

the neighbors what they thought. A few could remember wind generators in the area in the '30s and '40s, but they had all disappeared when the REA strung power lines through the area after World War II. That winter, our most frequent visitors were the county snow plows. Our corner of the country was plowed three and four times a day for the school buses and milk haulers (we live in dairy country). We quickly learned that leaving the homestead for a few hours could very well mean half a day of snow shoveling to get the car back home again.

After a few years of battling the wind and its effects, we decided to monitor our average wind speed. While the Green Bay airport and National Weather Bureau could still only muster a paltry nine mph annual average, our site turned up a surprising 13 mph at 100 feet after a year's monitoring. As we suspected, we did indeed have a respectable resource. So much for conventional wisdom!

### Lessons Missed

We actually had positive indications from several sources around us, but failed to see their value. The first was our intuition. While gut feelings are hardly scientific, it's pretty hard to discount the breeze that blows your laundry all over the township every time you use the clothesline.

Our second indication was the problem of continuously drifting snow. Crews work full time in our area to keep the roads open. Other areas of the country experience similar problems with dust, dirt, sand, and dried bits of vegetation constantly "sandblasting" the neighborhood.

Our third indication was the collective experience of various old timers and the locals. Living in the area, they have spent considerable time with environmental factors that newcomers like us may have discounted or never experienced.

Our fourth indication was the vegetation in the area. We'll get back to this one in a bit.

We made the same mistake most folks do when first investigating wind energy: attributing the final word on average wind speed for our site to professionally collected data at a less than ideal location.

### Assumption is the Mother of all Screw-Ups

Our problem occurred when we unquestionably accepted the value given to airport and weather data, considering their location versus ours. We discovered that weather bureaus monitor wind speeds at or slightly above street level, where people live. They do not monitor wind speeds at 80 or 100 feet, where wind generators live. And as we saw in Tower Economics 101 (HP#37) jumping from street level to 80 feet

substantially increases the average wind speed and, therefore, the power available in that wind.

Similarly, airport data has limited value. Because airplanes traditionally had problems taking off and landing in windy locations, airports were sited in rather sheltered locations. Virtually all airports are sheltered.

Most of the time the "professionals" really don't get it right. Without exception, all airports and weather bureaus I have visited have located their anemometers on the tops of buildings, next to trees, or in low spots on the terrain. In other words, their sampling equipment is either sheltered, or severely influenced by turbulence, or both. This helps to explain, for example, why the measured average wind speed at my site is greater than that recorded for the Green Bay airport. Taken at face value, professionally recorded wind speeds make a lousy yardstick for determining wind generator installations.

### Making it Useful

Does this mean that we should discount airport or weather bureau averages? Not at all. What it does mean is that their average wind speeds are in all likelihood very low baseline numbers, really just a starting point for our consideration. Virtually all wind generator sites I have seen have higher wind speeds by at least a mile per hour or two when compared to the nearest airport or weather bureau. Many times the disparity is three or four miles per hour, as we found at our site.

Consider the location, topography, surrounding vegetation and buildings, and the monitoring height of the recording station equipment (airport or weather bureau). By comparing these to your location, you can get a feel for the potential differences between the sites. Then by using the graphs in "Tower Economics 101" (HP#37), you can make an educated guess as to your average annual wind speed at hub height.

You may be in for a surprise when you call or visit your nearest wind recording station asking about the physical location of the monitoring equipment. Believe it or not, a very common reply is, "We're not really sure where it is." This response doesn't do much to build confidence in their numbers!

### Shear Factor

Another way of using nearby airport or weather bureau figures is to extrapolate their numbers to your location using a concept known as "shear factor". Based on their numbers and the topographical difference or similarity between your site and theirs, you can theoretically estimate your wind speed at any proposed height. I'll use our site again to explain how it's done.

**Surface Friction Coefficient**

from *The Wind Power Book* by Jack Park

Description of Terrain	$\alpha$
Smooth, hard ground; lake or ocean	0.10
Short grass on untilled ground	0.14
Level country with foot-high grass, occasional tree	0.16
Tall row crops, hedges, a few trees	0.20
Many trees and occasional buildings	0.22 – 0.24
Wooded country; small towns and suburbs	0.28 – 0.30
Urban areas, with tall buildings	0.40

**Table 1**

## How windy is it?

**Table 2**

**Height Correction Factor, H**

from *The Wind Power Book* by Jack Park

Height feet	Surface Friction Coefficient, $\alpha$								
	0.100	0.140	0.160	0.200	0.220	0.240	0.280	0.300	0.400
10	0.895	0.857	0.839	0.802	0.785	0.768	0.735	0.719	0.644
15	0.933	0.908	0.895	0.870	0.858	0.846	0.823	0.812	0.757
20	0.960	0.945	0.937	0.922	0.914	0.907	0.892	0.885	0.850
25	0.981	0.975	0.971	0.964	0.960	0.957	0.950	0.948	0.929
30	1.000	1.000	1.000	1.000	1.000	1.000	1.000	1.000	1.000
35	1.016	1.022	1.025	1.031	1.034	1.037	1.044	1.047	1.063
40	1.029	1.041	1.047	1.059	1.065	1.071	1.083	1.090	1.121
45	1.041	1.058	1.067	1.084	1.098	1.102	1.120	1.129	1.176
50	1.052	1.074	1.085	1.107	1.118	1.130	1.153	1.165	1.226
55	1.062	1.089	1.102	1.128	1.142	1.156	1.184	1.199	1.274
60	1.072	1.102	1.117	1.148	1.164	1.180	1.214	1.231	1.319
65	1.080	1.114	1.132	1.167	1.185	1.203	1.241	1.261	1.362
70	1.088	1.126	1.145	1.184	1.204	1.255	1.267	1.289	1.403
75	1.096	1.137	1.158	1.201	1.223	1.245	1.292	1.316	1.442
80	1.103	1.147	1.170	1.216	1.240	1.265	1.316	1.342	1.480
85	1.110	1.157	1.181	1.231	1.257	1.283	1.338	1.366	1.516
90	1.116	1.166	1.192	1.245	1.273	1.301	1.360	1.390	1.551
95	1.122	1.175	1.203	1.259	1.288	1.318	1.380	1.413	1.585
100	1.128	1.184	1.212	1.272	1.303	1.335	1.400	1.435	1.618
105	1.133	1.192	1.222	1.284	1.317	1.350	1.420	1.456	1.650
110	1.139	1.199	1.231	1.296	1.330	1.365	1.438	1.476	1.681
115	1.144	1.207	1.240	1.308	1.343	1.380	1.456	1.496	1.711
120	1.149	1.214	1.248	1.319	1.356	1.394	1.474	1.515	1.741
125	1.154	1.221	1.257	1.330	1.368	1.408	1.491	1.534	1.769

Let's be daring and assume that the recording station knows the whereabouts of their anemometer, and that it is on the standard 30 foot tower it's supposed to be on. You visit their location and find that the anemometer is in a very well-exposed site, far from the influence of any trees or buildings. The recording station tells you that the average wind speed at the site for a 35 year period of time is 9.0 mph. What does this translate to at your site?

The first thing you do is estimate the similarity of your site to theirs and assign your site a surface friction coefficient from Table 1.

Assuming that their site is wide open and your site is like ours, a farm with the usual buildings and trees plus a nearby wooded area, you might choose a surface friction coefficient of 0.24. We have a 100 foot tower that we would like to use to mount the wind generator. At 100 feet, we will easily pass the "30 feet above anything within 500 feet" rule (see Tower Economics 101). What kind of average wind speed can we expect at this height?

If we look across the 100 foot row in Table 2 to the column labeled 0.240, we find a correction factor of 1.335. Multiplying 1.335 by the recording station's figure of 9.0 mph means that we can expect an average annual wind speed of 12.0 mph at our site. While this is still below the actual measured average wind speed of 13.0 mph at our site, it's a lot closer than 9.0 mph!

The one caveat in using this technique is the assumption that the recording station's anemometer is not surrounded by trees and buildings. If it is, the shear factor technique of estimating wind speeds does not work very well.

**Flagging**

Another useful tool to help determine the potential of a wind site is to observe the area's vegetation. Trees, especially conifers or evergreens, are often influenced by winds. Strong winds can permanently deform the trees. This deformity in trees is known as

“flagging”. Flagging is usually more pronounced for single, isolated trees with some height.

Pictured here is a pine tree in my yard with an obvious wind swept deformity. The upper part of the tree is swept back and away from the solar shower next to it. On the upwind side of the tree, the branches are noticeably stunted. On the downwind side, they're long and horizontal. The flagging was caused by persistent winds from, more or less, one direction.

Ecologists have been using flagging in trees for decades to ballpark the average wind speed for an area. (Vegetables don't lie!) Pick up any ecology book and you will find a diagram similar to the one bottom right on the page that quantifies an area's wind speed as a function of tree deformity.

Note that you can get an idea of the average wind speed by the amount of flagging. Comparing the picture to the diagrams, we could categorize my pine tree as Class III, an 11 to 13 mph average wind speed. The monitoring done at my site certainly bears this out.

If you do not have any conifers in your area, look around at the deciduous trees. They may also show evidence of flagging. Look around especially for single trees, or trees on the outskirts of a grove. Unless they have grown considerably above the common tree line, trees in a forest will not show flagging because the collective body of trees tends to reduce the wind speed over the area.

While the presence of flagging positively indicates a wind resource, you should not conclude that the absence of flagging in your area precludes any suitable average wind speeds. Other factors that you are not aware of may be affecting the interaction of the wind with the trees.

**Tools Revisited**

So far, the tools that we have available to us for approximating our wind resource are:

- The various experiences of your area's neighbors, especially the old timers
- Any flagging that might be observed in the surrounding areas
- Local wind generated problems (snow drifting, severe soil erosion, tumbleweeds)
- The average wind speed established by the nearest airport or weather bureau, which can be used as our baseline
- The average wind speed for your site as determined by the shear factor
- Your gut feelings based on all of the above



Above: Moderate flagging on a tree tells you how much wind is blowin' through.

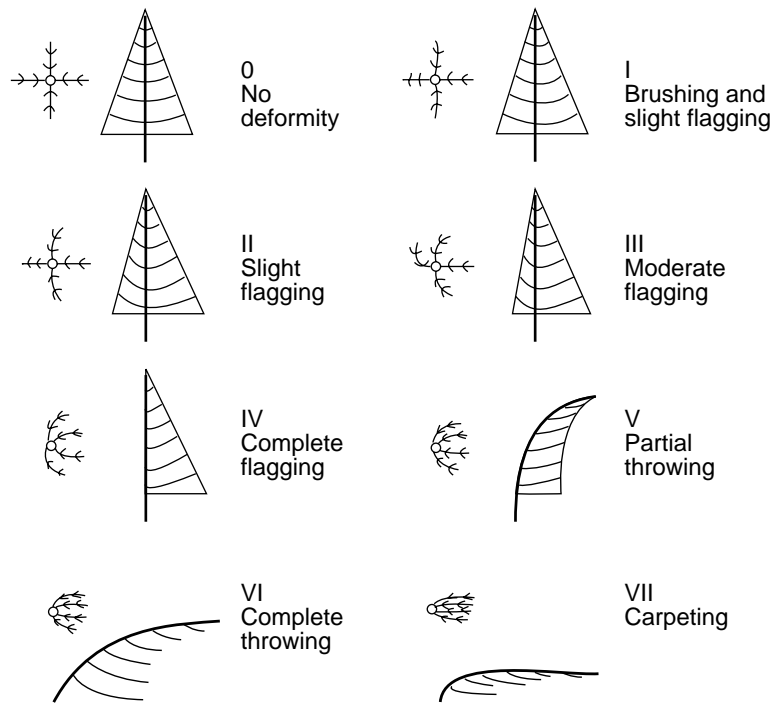

**Griggs-Putnam Index of Deformity**

from *Wind Power for Home & Business* by Paul Gipe

Index	I	II	III	IV	V	VI	VII
Wind Speed (mph)	7-9	9-11	11-13	13-16	15-18	16-21	22+

## Wind

### Power Increase vs. 1 mph Wind Speed Increase

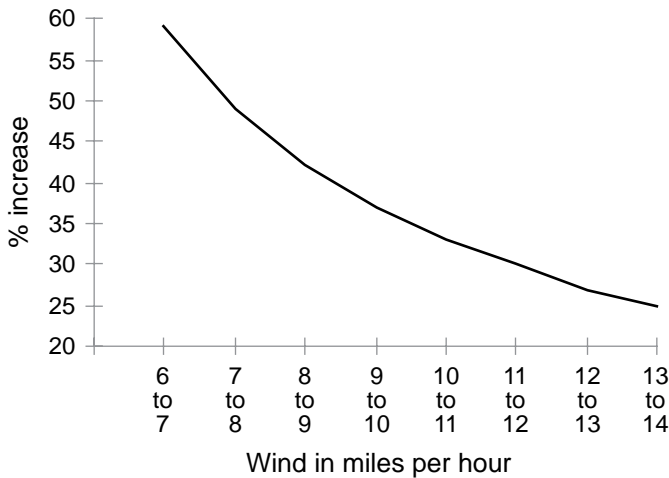

Remember from "Tower Economics 101" that even small increases in wind speed can yield substantial increases in power to the wind generator because velocity is cubed in the power equation. This is especially true at lower average annual wind speeds, as depicted in the graph above.

#### The Bottom Line

So what is the bottom line number for an acceptable average wind speed? Because there seems to be such

a disparity between monitoring stations (airports and weather bureaus) and actual wind generator installations, we can actually fudge a little here. For a utility intertie system with a good exposure compared to the monitoring station site, an average wind speed of eight mph at the recording station or at ground level at your site is acceptable. Remember, our economic cut-off point (if you're doing this to make money) is ten mph at hub height when we're competing with cheap utility power.

For a battery charging wind system in which the monitoring station has nearly identical topographical exposure to your site, an annual average wind speed as low as seven mph at the recording station or at ground level at your site is acceptable. If the monitoring site is very sheltered compared to your site, this number could drop to about six mph. However, I wouldn't consider any site with average wind speeds less than these.

Next time we'll take a look at maximizing the usefulness of your site.

#### Access

Mick Sagrillo gets blown around a lot at Lake Michigan Wind & Sun, E 3971 Bluebird Rd., Forestville, WI 54213 • 414-837-2267



## *There's Something in the Air!* **Tehachapi Wind Fair '94**

**Mountain Valley Airport**  
*(Off Highline Road)*  
**May 21-22, 1994**

For More Information Contact:  
Tehachapi Wind Fair  
P.O. Box 1089, Tehachapi, CA 93581  
*or*

Kern Wind Energy Association at 805 822 7956  
Mountain Valley Airport at 805 822 5267  
Word Merchant at 805 822 3222

**Join  
the  
Fun!**

**SAILPLANE RIDES • WIND FARM TOURS  
STUNT KITES • SKYDIVERS • SOLAR PANELS • WIND TURBINES  
HIKING • FOOD • GAMES • ELECTRIC VEHICLES • BOOMERANGS •  
WIND, SUN, FUN FOR THE WHOLE FAMILY**

# Site Analysis for Wind Generators

## Part 2: Your Site

Mick Sagrillo

©1994 Mick Sagrillo

In our last episode (HP#40), we outlined some ways of estimating the wind resource in your area. We also developed a method to determine the average wind speed at hub height for your proposed wind generator. The question before us now is: where on your property is the best place to put your wind generator tower?

The answer to this one is easy. Put the tower where it's windiest! It is actually windier in some places on your property than on others. In this article, we will show you how to analyze your specific location so that you can maximize your wind resource.

### Tools

The purpose of examining any potential renewable energy (RE) site is to optimize the RE resource, and therefore, the power output of the proposed RE generator. To accomplish this, you will need to gather some information about your site, such as:

- Location of vegetation and buildings
- Prevailing wind direction/directions
- System voltage (battery charging systems only)
- Surface roughness or topography.

From this information, we will develop a series of rules or guidelines that will help you qualify the resource at your site.

### Vegetation and Buildings

Since any site analysis requires a specific location, we'll use our homestead as an example. Figure 1 illustrates the layout of the buildings and most trees on our property. Also noted are the compass points, and a distance scale. The numbers indicate the approximate heights of the trees and buildings.

The terrain in our area is somewhat rolling and relatively open, but spotted with buildings, overgrown fencerows, groves of trees, and the occasional woodlot (several

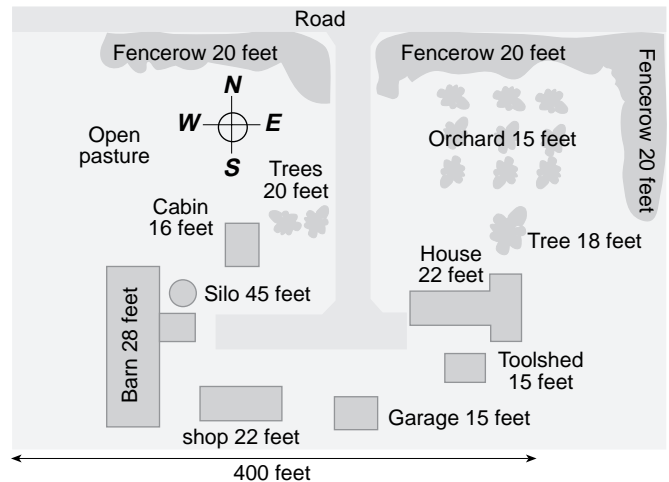

Figure 1

hundred acres). While we live in farm country with some forested areas, this site need not be rural, strictly speaking. It could very well be a small town, suburban development area, or the edge of a larger city.

### Tower Height

Remember from "Tower Economics 101" (HP#37) that our arch enemy is turbulence. It robs us of our fuel, the wind, and puts unnecessary wear and tear on the wind generator. Therefore, rule #1 is: minimize turbulence as much as possible. We'll return to turbulence later.

Another important consideration is that the wind generator must be at least 30 feet above anything within 500 feet — a *minimum* requirement. Let's call this rule #2. For anything larger than about 1 kiloWatt (kW), the "30 foot" above rule must include the blades as well.

As an example, let's assume that we will install a large wind system, say a high voltage 10 kW wind generator with a 24 foot rotor diameter. If we add the radius of the rotor (12 feet) to the 45 foot silo and the "30 foot above rule", we find that the minimum tower height for this location is 87 feet. Since an 87 foot tower is not readily available, we'll opt for the next closest size, 90 feet. Notice that we went up in height rather than skimp with an 80 foot tower. This is the minimum tower height for this location given a 10 kW wind generator.

We have the wind generator, system voltage, and tower height selected. Our next question is where do we put it to best utilize our wind resource.

### Prevailing Winds

To answer this question, we need to know the seasonal wind patterns for this proposed site. This should be fairly obvious for your location if you have lived there for a least a year. If you are new to the area, ask your neighbors.

At our place, the wind blows quite regularly during the fall, winter, and spring. Summer winds are restricted to frequent thunderstorms. While brief, these storms are usually accompanied by high winds for several hours.

Winter is dominated by winds out of the north and northwest. Fall and spring bring winds from the south and southwest. While the winds from a summer storm come from any direction, they arise most frequently out of the west. We can see a pattern developing here (Figure 2).

The best place for the tower which optimizes our prevailing wind directions is west of the barn. We now have rule #3: after you determine the direction of the prevailing winds, site the wind generator upwind of any buildings or trees.

But Mick, you say, the wind sometimes blows from the northeast, east, and southeast. At those times, the tower and generator are downwind of the trees and buildings and in the zone of turbulence. Won't we have problems when the winds are from these directions?

Unless we install a movable tower (something no one has perfected yet), the answer is yes. Because the wind blows from any compass direction some of the time, we have to compromise. Since we are interested in where the wind blows most of the time, we have to accept that occasionally the tower is in a less than ideal location. This brings us to rule #4: in a site analysis, tower placement minimizes those compromised locations, thereby maximizing our wind resource.

### Wire Restrictions

Since we know the rotor size and building height, we can easily determine the minimum tower height at this location. The distance of the wind generator to its controller is of little concern because it is a high voltage system. We can locate the tower almost anywhere on the property without worrying too much about wire size.

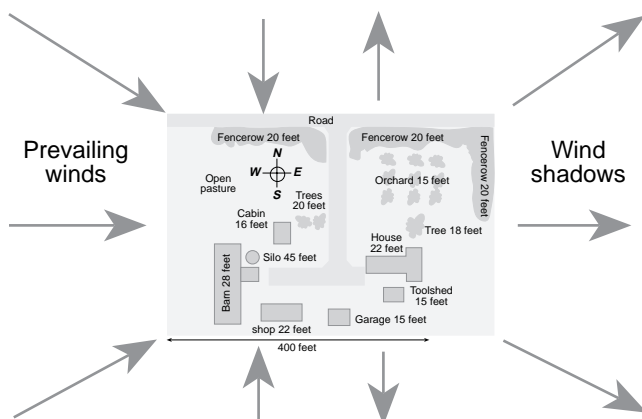

Figure 2

In a wind system, your wire run includes the distance from the tower to the controller plus the tower height, and back again. Because wire runs in a wind system can add up fast, higher voltage systems are preferable. Why is this, you ask. The power that a wind generator produces is a function of volts multiplied by amps. Thus, voltage and current are inversely related. If the voltage doubles, the current carried by your wires is cut in half, for a given amount of power.

The power lost in a wire run is a function of the wire's resistance (a function of the length and diameter) multiplied by the square of the amps that the wire carries. For a given wire gauge, doubling the voltage means that the wind generator can be located four times the distance and still have the same power loss! With wind generators, higher system voltages are easier to work with and more cost effective than lower system voltages. Which brings us to rule #5: raising system voltage gives you considerable flexibility in where you can put the tower.

### Low Voltage Dilemma

Now, let's muddy the waters by lowering the voltage. Rule #3 would favor the location west of the barn. A tower near the house would be downwind of buildings and trees. It would see a lot of turbulence and reduce our power output. "Tower Economics 103" (HP#39) diagrammed the zone of turbulence behind such obstructions.

But let's suppose that we already have a low voltage system in the house, and upgrading to a higher voltage is not an option. The distance from the proposed tower site west of the barn to the house is 400 feet. Add the 90 foot tower height, and we have a low voltage dilemma. We cannot run 12 Volts for nearly 500 feet. Now what do we do, Mick?

We can opt to move the tower closer to the house. If we place the tower within 30 or so feet of the house, we reduce the wire run to under 150 feet. This will require some gonzo wiring, but is acceptable cost-wise. But now the only place for the tower is downwind of the buildings, which puts us into a zone of turbulence (see Figure 2).

Installing a wind generator tower is not like plopping PVs on the ground somewhere. It is a considerable project, involving concrete. We want to get it right the first time (concrete is not very forgiving). Therefore we must determine the extent of the turbulent zone at our proposed tower site.

### Mr Wizard!

Now comes the fun! You will need a "giant weather balloon", the kind available from scientific mail order

## Wind

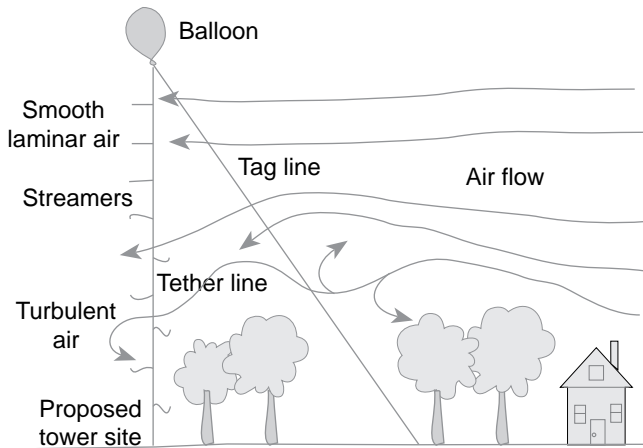

**Figure 3**

Adapted from *Wind Power for the Homeowner* by Don Marier

stores. (Admit it; you always wanted one of these as a kid. Now, you have an excuse to buy one!) Take it down to your local FTD florist, the folks who sell helium filled anniversary and birthday balloons. Have them fill it with helium. You might want to do this outside. Few florists have enough room (especially florists specializing in cacti) or doors wide enough to accommodate six foot weather balloons.

Once you get the damn thing home in one piece, it's time to conduct our experiment. Whatever you do, don't let the balloon go or it's back to the florist. Get someone to help (Mr. Wizard always has an assistant) rather than attempt this alone. Tie the balloon to a nylon cord about 100–120 feet long. This is your tether line. The other end of this cord should be securely fastened to a stake driven into the ground. Place the stake where you want the tower to be. Tie a second nylon cord, about 200 feet long, to the balloon. This is your tag line.

As your helper lets out the tether line with the balloon, tie streamers made of four feet long pieces of yarn or crepe paper every ten feet along this line. Keep the tag line from getting tangled up in the tether line and streamers. Tie the tag line off in the upwind direction once the balloon is in the air. Get the balloon to fly directly over your proposed wind site, as in Figure 3.

Why, you ask, are we doing all of this? Elementary, my friend. We are trying to determine the boundary layer where turbulence ends and smooth flowing laminar air begins. The streamers in the turbulent zone will ruffle in the wind, whipping around in all directions. Once you cross the boundary layer and reach the undisturbed air, the streamers straighten out and only blow downwind of the tag line. Count off the streamers to determine the height of the smooth flowing air. This is the minimum height for your wind generator tower.

Do this experiment over a period of days, with winds coming from different directions and at various speeds. This way you will have a good sample for determining the turbulent zone around the proposed wind site. You'll need to relocate the tag line from day to day as the wind shifts directions. When not in use, bring the weather balloon down so that a shifting wind does not blow it into a balloon-eating tree. If you live in a town or populated area, this technique is especially good to use to qualify your wind resource. By the way, this experiment is sure to bring every kid in the neighborhood to your yard.

You may discover that the boundary layer raises in height at higher wind speeds or when the wind comes over a building from a particular direction. Since you want to stay clear of the turbulent winds, you will need to determine the upper limits of the boundary for most wind conditions.

If you actually do the above exercise, you will empirically discover rule #6: rougher surfaces produce gustier winds, especially at higher wind speeds. The solution? It's rule #7: if you must be downwind of obstructions, raise your tower height to get out of the turbulent zone and into the laminar flow of air. Don't forget that the blades need to be completely above the boundary layer as well.

### Estimating Heights

Let's assume that we are upwind of all obstructions again. We know that we still need to get the wind generator 30 feet above the downwind obstructions. But we don't know how tall the neighboring buildings and trees are. How can you determine their heights without risking your neck with a tape measure in hand?

One way is what I call the "shadow method". Suppose we want to know how tall our barn is. On a sunny day, drive a stake into the ground and measure the height of the stake above ground. Let's say it's four feet tall. Then measure its shadow. Let's say that the shadow

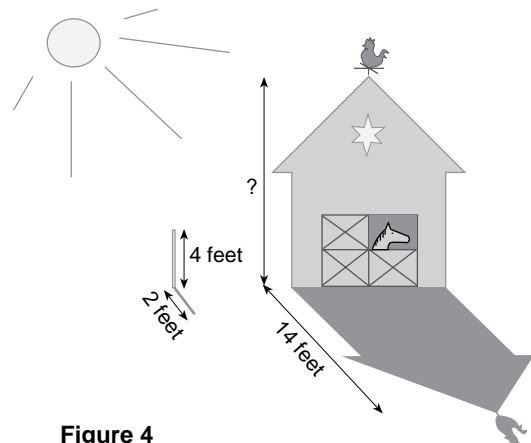

**Figure 4**



extends two feet. Next, measure the shadow that is cast by the barn. Let's say it's 14 feet. (See Figure 4)

Using the formula, we can determine the height of the barn without climbing.

$$\frac{\text{Stake height}}{\text{Stake shadow length}} \times \text{Barn shadow length} = \text{Barn height}$$

$$\frac{4 \text{ feet}}{2 \text{ feet}} \times 14 \text{ feet} = 28 \text{ feet}$$

Piece of cake! The barn is 28 feet tall.

But what happens if the sun doesn't shine in your area? Another way of determining heights is called the triangulation method (see Figure 5 below).

Let's say that we need to know the height of a nearby tree. With a 12 inch ruler in hand, stand far enough away from the tree so that when you hold the ruler in your outstretched hand and site past it to the tree, the tree is slightly smaller than the ruler. With ruler still in hand, record the height of the tree in inches (distance A, say, 10 inches). Then measure the distance in inches between the ruler and your eye (distance B, say, 30 inches). Finally, measure the distance, in feet, between the place where you were standing and the tree (distance C, say 180 feet). Now use the following formula to determine the height of the tree (distance D).

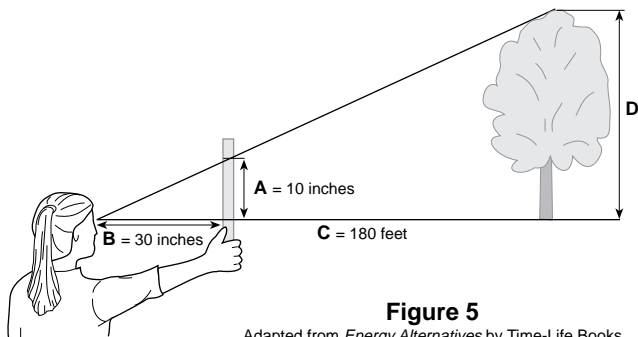

**Figure 5**

Adapted from *Energy Alternatives* by Time-Life Books

$$D = C \times \frac{A}{B} \text{ or } D = 180 \text{ feet} \times \frac{10 \text{ inches}}{30 \text{ inches}} = 60 \text{ feet}$$

Simply and safely, our tree is 60 feet tall!

### Trees, Trees, Trees

Let's assume that we have not just one tree, but an entire forest of trees. We have done the above exercises, and we know that the forest canopy is about 60 feet tall. Is a wind generator still practical?

Sure, but we need to get the generator at least 30 feet above the top of the tree line. In this case, we need to know the approximate age of the trees, their species, and the height that these particular types of trees will reach at this location. Why? Because of rule #8: trees grow, towers don't!

If the forest is made up of maples and ash, and the canopy is 60 feet high, you can be fairly confident that these trees are mature and will not grow much taller. You would be safe with a 90–100 foot tower. If the 60 footers are Douglas fir trees and you install a 90 foot tower, you can be assured that in not too many years the wind generator will be engulfed by branches. In most areas, Doug fir will be more than 90 feet tall. Your time and investment will have been wasted.

### And More Trees!

Let's complicate the situation a little. Assume that you own ten acres of cleared land in a national forest made up of oaks or aspen trees. Either species will mature at around 40 feet in your area. Your house is only 18 feet tall and situated smack dab in the middle of the ten acres. That puts you at least 500 feet away from the trees. Since you are 500 feet away from the nearest obstacle except the house, you can get by with a 48 foot tower. Right?

Not in this case. While it may seem that you are an adequate distance away from the trees, you are essentially in a sheltered hole! The tree canopy is the effective ground level as far as the wind is concerned. A 48 foot tower at this location would be analogous to an eight foot tower on open ground.

The minimum tower height in this instance would be 70 feet (40 foot trees plus the "30 foot rule"). If you wanted to install a 1 kW wind generator with a ten foot rotor, a safer bet would be to include the radius of the rotor (or length of a blade) at five feet, to this height. This would put the tower height at 75 feet. Since there are no other obstacles above the forest canopy, prevailing wind direction is of little concern to us.

One final note about trees: avoid putting towers amidst a dense group of trees. It complicates the installation and jeopardizes the safety of the installer or service people climbing the tower. You don't want tree branches rubbing on the tower. It's not safe for the tower or the trees.

### To Tree or Not to Tree

Folks who live around tall trees may feel discriminated against when it comes to tower height. They're right. But that's the price one pays for living in a tall neighborhood. Figure 6 graphically represents what I am talking about.

If we assume a given location with a given wind speed at any point in time, Figure 6 depicts how tall your tower must be at a minimum to compensate for the surrounding vegetation. Does this mean that you should cut down all of your trees? Hardly! Just ask anybody in Kansas about the value of shade. Does this

Figure 6

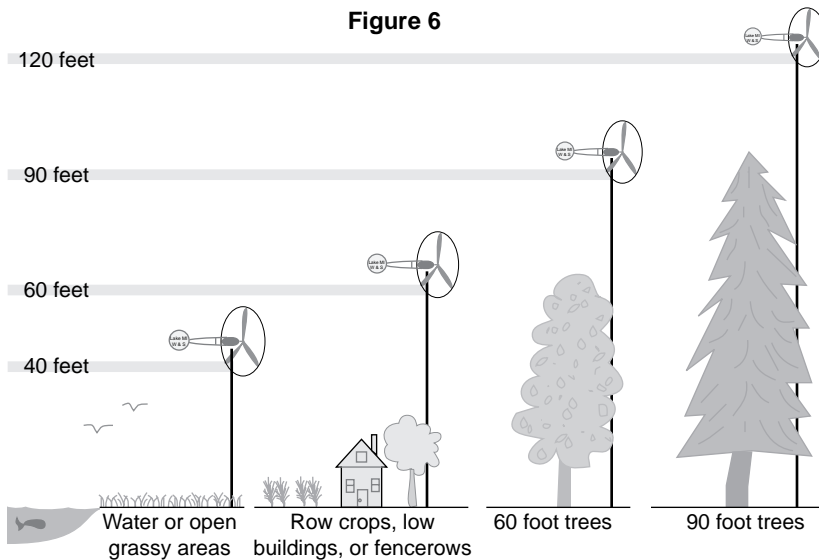

mean that a wind system in an area with tall trees is impractical? Not at all. No matter where you live, you still have to install the wind generator on a tower. So what we are discussing is the incremental cost increase of an additional 30 feet of tower compared to the cost of the entire system. ("Tower Economics 102" in *HP*#38 discusses this subject in detail.)

### Low Voltage Options

Since many *Home Power* readers already have low voltage systems, and a goodly number also probably live near tall trees, let's revisit this issue.

Going back to rule #5, I recommend increasing system voltage first. Resistance to change aside, this will always be the cheapest option. In addition, systems need not be restricted in total power output. A 12 Volt system, for example, is limited to a power output from a few hundred watts to about 1.5 kW. Due to the amount of current that must be generated, building 12 Volt wind equipment larger than this capacity is just not practical. Because of this, 12 Volt systems larger than 1.5 kW are not even commercially available.

There are, however, a few tricks that are available to low voltage system users facing extremely long wire runs. Many of the newer wind generators utilize permanent magnet alternators. These alternator's produce something called three phase wild ac, which is rectified to DC with diodes in the system's controller before travelling to the battery bank. A three phase wind system utilizes three wires to transmit current down the tower to the controller. A DC system only uses two wires, positive and negative.

The advantage of three phase ac is that the current produced by the alternator is split up and transported equally by its three wires. By contrast, all the current

produced by a DC generator is transported down a single wire. Three phase alternators can use lighter gauge wire for a given wind generator capacity at a given distance. Therefore, three phase permanent magnet wind generators offer greater flexibility in siting — they allow longer distances from the battery.

### High Voltage Transmission

One final trick that can be used for low voltage systems is to actually install a high voltage wind generator, but then step the voltage down at the batteries. With a three phase ac alternator, the solution is simple: use a three phase step-down transformer before the rectifiers. These transformers are relatively inexpensive when compared to cost of enormous wires.

Transformers are only about 85% efficient, so some power is lost in the process. The efficiency can be boosted somewhat by adding capacitors to the system. While a 15% loss of efficiency may be considered extreme by some, it is a small price to pay when the option is a much-compromised tower location tethered to welding cable-sized wires.

There is no such thing as a DC transformer for systems utilizing a DC wind generator. However, a linear current booster (LCB) performs essentially the same function as an ac step-down transformer. An LCB is a high speed switching device that will allow the user to transmit high voltage DC, reducing the voltage at the battery bank. LCBs are also about 85% efficient. They are, however, more expensive than transformers.

While neither the transformer nor the LCB is a cheap option, they do allow the user to cut down on the size wire needed. In many cases, these devices more than pay for themselves in money and aggravation when compared to the cost of heavy-duty wires. But their big advantage is that they allow the user to site their wind system at the most ideal location rather than compromise with less than ideal tower placement. We have customers using these devices that have sited their wind generators as far as 2000 feet from their battery bank.

### Sounds of Silence Broken

You may be thinking, why not virtually eliminate the wire run by just mounting the tower right on top of their house. Don't even consider this idea for several reasons. First of all, few roofs have the structural beefiness to support the loads presented by a wind generator and tower, let alone when the wind is trying to blow them over.

Second, even if your roof was strong enough or the tower was short enough or the generator was light enough, there is another serious drawback to this idea. Any rotating electrical generating device produce a harmonic that we can perceive by touch as a vibration. That harmonic vibration is transmitted down the tower. Touch one sometime and you will feel what I mean.

If the tower were attached anywhere to a building, the building itself would begin to resonate, similar to a guitar's sounding box. This resonance would vibrate the building, doing who knows what kind of structural damage over time. In addition, the resonance would develop into sound inside the building. Unless you are deaf and don't mind things walking off horizontal surfaces or jumping off walls whenever the wind is blowing, this is a pretty bad idea.

### Recap

Proper siting of a wind generator tower is actually easier than initially meets the eye, if you remember the following guidelines:

1. Minimize turbulence.
2. Install the tower at least 30 feet above anything within 500 feet.
3. Note your prevailing winds and stay upwind of any obstacles.
4. Minimize compromises in location, voltage, and tower height.
5. Consider higher voltages.
6. Rougher surfaces produce gustier winds.
7. If downwind of obstacles, compensate with a taller tower.
8. Trees grow, tower don't.
9. Never attach the tower to your house.

You now have the tools to properly site your wind generator. Take the time to ask questions and do it right. You will be rewarded with a system that takes the best advantage of one of Nature's greatest and most powerful gifts: the wind.

### Access

Mick Sagrillo flies his balloons at Lake Michigan Wind & Sun, E 3971 Bluebird Rd., Forestville, WI 54213 • 414-837-2267

Giant weather balloons:

American Scientific and Surplus, 3605 Howard St., Skokie, IL 60076 • 708-982-0870

Edmund Scientific, C911 Edscorp Building, Barrington, NJ 08007 • 609-547-8880



## Let the sun move your tracker!

TRACK RACK™, our passive solar tracker, uses fluid-filled tubes that follow the warmth of the sun and move your photovoltaic modules for you!

- Gain 20 to 55 percent more power
- Savings equal to 3 extra modules a year
- No batteries or gears to replace
- No electronics or motors to fuss over

LIFETIME WARRANTY

Prompt Delivery • Fixed Racks Also Available

Call for your nearest dealer

1-800-279-6342

Double your outdoor battery life with our **COOL CELL™**  
Passive Temperature Regulating Enclosure

## ZOMEWORKS CORPORATION

1011 Sawmill Rd NW, Albuquerque, New Mexico 87104 USA

**SIEMENS**

Solar Power Your Dream

Whether you plan to build, Siemens can help turn your plans into reality with customizable solar electric power systems.

Simply, without fuel or pollution, a Siemens solar system can supply you with your own power of trouble-free, clean, safe, track-out noise and more safety. It is to have a better, to meet all or part of your electrical needs.

Save Your Green! Solar Power Your Home!

**POWER UP!**

With TRACE Inverters

• 120 Volt AC Electricity from your Battery Bank

• Power to Run Tools, Computer, Microwave, TV, VCR, Refrigerator, Lights and Electronics

• Most Models Include a State-of-the-Art 3-Stage Battery Charger

**TRACE ENGINEERING**

**Siemens Modules**

M55 \$315@

M75 \$305@

PC4JF \$399@

Includes Shipping to Lower 48 States

Prices per Boxes of 4

LIMITED TIME OFFER

**INVERTER TRADE-IN PROGRAM**

Trade in Your Old Inverter for a New Trace 4000 Sine Wave Inverter

SEND SASE FOR DETAILS

**ALTERNATIVE POWER RENEWABLE ENERGY CENTER**

701 S. MAIN

WESTBY, WI 54667

608-634-2984

SOLAR POWERED SINCE 1980

SEND SASE FOR USED EQUIPMENT FLYER